

Company Name: _____

Phone: _____ Client: _____

QUOTE ORDER PO# _____

W/C Make: _____

W/C Model: _____

W/C Width: _____

Back Cane Tubing

- 7/8" Tubing Size
 1" Tubing Size
 Other : _____

Note: Selections must be made in Step 1,2,3,5 & 6. check all options clearly, if selections are not made in required fields then standard/default options will be selected.

Step 1 Back Style Please Select ONE Back Style

- 1 **Custom Configured Back #13009-01** \$450.00
w/mounting hardware (E2617)
- 1 **Back Planar, Pediatric #13009-PE** \$384.00
w/mounting hardware (E2291)
- 1 **Solid Back Insert (with straps) #13009-SBI** \$244.00
1/4" wood, Not for attachment (K0108)

A- _____
B- _____

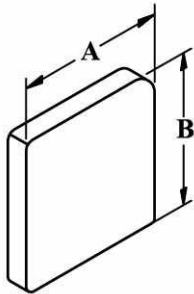

- Custom Contoured Back #13009-SBA** \$484.00
w/mounting hardware (E2617)

A- _____
B- _____
C- _____
D- _____

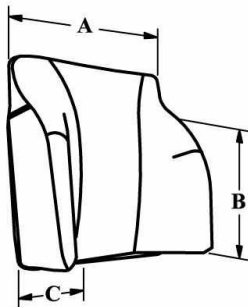

- Accu-Fit Back™ w / adjustable contoured laterals and mounting hardware (E2617)
- Accu-Fit Back Height (Measurement **(B)**) _____
- Accu-Fit (SMALL) built-in adj. contoured laterals #13009-02 \$700.00
- Accu-Fit (MEDIUM) built-in adj. contoured laterals #13009-03 \$700.00
- Accu-Fit (LARGE) built-in adj. contoured laterals #13009-04 \$700.00
- Accu-Fit (CUSTOM size) built-in adj. contoured laterals #13009-05 \$840.00

(C) _____ Depth **(D)** _____ Height

- Accu-Fit **FIP KIT** (Foam-In-Place) 1/2 Unit size #13011-FIP \$154.00
- Accu-Fit **FIP KIT** (Foam-In-Place) 1-Full unit size #13011-FIP2 \$209.00

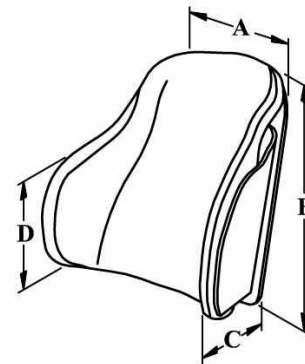
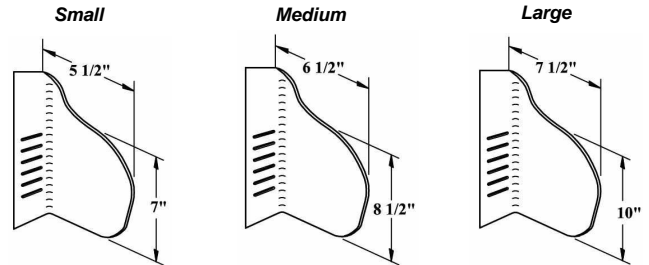

Step 2 Back-Mount Information

- Between Back Rails** (standard)
back width will be 3" narrower than chair width
- In-Front of Back Canes "Full width Back" (no charge)
- Oversized Back Upgrade #13010-05 \$67.00
actual back width over 19" or height over 23"
- T-Nut for Attachment** (standard)
- 2 Track Mount Hardware (Recommended) #13010-TM2 \$52.00
- Omit T-Nuts (\$6.00)

Office Use Only:

Accu-Fit Seating™

Back Options Sheet

Step 3

Mounting Hardware-Options

- J & L Hardware Mounting Kit** (standard)
select one "J" and one "L" length below
- | | | | |
|--------------------------------------|--------------------------------------|--------------------------------------|--------------------------------------|
| <input type="checkbox"/> 2-Hole "J"s | <input type="checkbox"/> 7-Hole "J"s | <input type="checkbox"/> 1-Hole "L"s | <input type="checkbox"/> 5-Hole "L"s |
| <input type="checkbox"/> 4-Hole "J"s | <input type="checkbox"/> 9-Hole "J"s | <input type="checkbox"/> 2-Hole "L"s | <input type="checkbox"/> 7-Hole "L"s |
| | | <input type="checkbox"/> 3-Hole "L"s | <input type="checkbox"/> 9-Hole "L"s |
- Omit Mounting Hardware (\$35.00)
- Velcro Hook & Loop Attachment (*back pan mount*) #13009-PM \$16.75
- Zero Inch Drop, U-Clamp Hardware Mounting Kit #2199-99 \$17.00
- One Inch Drop, U-Clamp Hardware Mounting Kit #2200-99 \$17.00
- Knob Release Kit (4-Point Mount) #13010-19 \$566.00
- 3 Knob Release Kit (2-Point Mount) #13010-15 \$415.00
w / seat-to-back brackets (*specify below*)
- Flush bracket 1" Offset 2" Offset 3" Offset

Step 4

Back Options-Continued

(choose multiple options)

- 4 Curved ABS Back upgrade #13010-C \$122.00

A- _____
B- _____

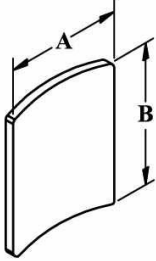

- I-Back upgrade #13010-I \$84.00

A- _____
B- _____
C- _____
D- _____
E- _____

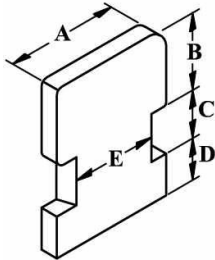

- T-Back upgrade #13010-T \$84.00

A- _____
B- _____
C- _____
D- _____

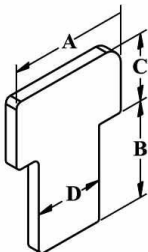

- Rounded-Top Back upgrade #13011-RT \$67.00

A- _____
B- _____

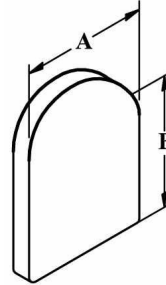

- Adjustable Foam Lumbar support (built-in) #13010-LS \$67.00

A- _____
B- _____

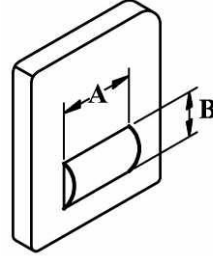

- Bi-Angular locking/hinged Back #13010-BI \$155.00

A- _____
B- _____
C- _____

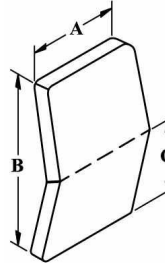

Step 5

Foam Options & Upgrades

(Base-Layer Foam)

Etha-Foam (high density)

- 1/2" Etha-Foam #13030-01 \$15.00
- 1" Etha-Foam #13030-02 \$24.75
- 1.5" Etha-Foam #13030-03 \$37.00

Neoprene Foam

- 1/2" Neoprene Foam #13030-04 \$27.00
- 1/2" Neoprene Foam (standard Accu-Fit Back only)

Poly Foams

- 1/2" Soft Polyurethane Foam #13030-05 \$7.61
- 1/2" Medium Polyurethane Foam #13030-07 \$15.23
- 1" Soft Polyurethane Foam #13030-06 \$15.23
- 1" Medium Polyurethane Foam #13030-08 \$22.84

Visco Elastic

- 1/2" Super Soft Visco Elastic Foam #13030-09 \$37.00
- 1/2" Soft Visco Elastic Foam #13030-11 \$37.00
- 1" Super Soft Visco Elastic Foam #13030-10 \$73.00
- 1" Soft Visco Elastic Foam #13030-12 \$73.00

SunMate Brand Foam

- 1/2" Soft SunMate Foam #13030-13 \$49.00
- 1/2" Medium SunMate Foam #13030-15 \$49.00
- 1" Soft SunMate Foam #13030-14 \$97.00
- 1" Medium SunMate Foam #13030-16 \$97.00

Accu-Fit Seating™

Back Options Sheet

Step 5 Foam Options-Continued

(Mid-Layer Foam)

Poly Foams

- 1/4" Soft Polyurethane Foam #13040-01 \$4.57
- 1/2" Soft Polyurethane Foam #13040-02 \$7.61
- 1/2" Medium Polyurethane Foam #13040-04 \$15.23
- 1" Soft Polyurethane Foam #13040-03 \$15.23
- 1" Medium Polyurethane Foam #13040-05 \$22.84

Visco Elastic

- 1/2" Super Soft Visco Elastic Foam #13040-06 \$37.00
- 1/2" Soft Visco Elastic Foam #13040-08 \$37.00
- 1" Super Soft Visco Elastic Foam #13040-07 \$73.00
- 1" Soft Visco Elastic Foam #13040-10 \$73.00

SunMate Brand Foam

- 1/2" Soft SunMate Foam #13040-11 \$49.00
- 1/2" Medium SunMate Foam #13040-13 \$49.00
- 1" Soft SunMate Foam #13040-12 \$97.00
- 1" Medium SunMate Foam #13040-14 \$97.00

Neoprene Foam

- 1/2" Neoprene Foam #13040-15 \$27.00

(Top-Layer Foam)

Poly Foams

- 1/4" Soft Polyurethane Foam #13050-01 \$4.57
- 1/2" Soft Polyurethane Foam #13050-02 \$7.61
- 1/2" Medium Polyurethane Foam #13050-04 \$15.23
- 1" Soft Polyurethane Foam #13050-03 \$15.23

5 1" Medium Polyurethane Foam (standard)

Visco Elastic

- 1/2" Super Soft Visco Elastic Foam #13050-06 \$37.00
- 1/2" Soft Visco Elastic Foam #13050-08 \$37.00
- 1" Super Soft Visco Elastic Foam #13050-07 \$73.00
- 1" Soft Visco Elastic Foam #13050-09 \$73.00

SunMate Brand Foam

- 1/2" Soft SunMate Foam #13050-10 \$49.00
- 1/2" Medium SunMate Foam #13050-12 \$49.00
- 1" Soft SunMate Foam #13050-11 \$97.00
- 1" Medium SunMate Foam #13050-13 \$97.00

Neoprene Foam

- 1/2" Neoprene Foam #13050-14 \$27.00

**Akton Brand Polymer Gel
Overlay-full sheet**

- 1/2" Poly-Gel (Cubed) #13050-16 \$320.00
- 1/2" Poly-Gel (Flat) #13050-15 \$320.00
- 1/2" Poly-Gel (Cubed) > 20" width or ht. #13050-18 \$402.00
- 1/2" Poly-Gel (Flat) > 20" width or ht. #13050-17 \$402.00

6 Inlay half-sheet

- 1/2" Poly-Gel Inlay (Cubed) #13050-20 \$122.00
 - Top Middle Bottom
- 1/2" Poly-Gel Inlay (Flat) #13050-19 \$122.00
 - Top Middle Bottom

Back options & foam layer notes:

Step 6 Upholstery Options & Upgrades

- Dartex fabric side (standard)
- Incontinent Inner-Liner Cover #13008-1C \$122.00
- Dartex reversed (smooth side) **no charge**
- 7 Naugahyde / Vinyl (contact surface only) #Uph-01 \$25.00
- 7 Cordura fabric (contact surface only) #Uph-02 \$25.00
- Naugaform Vacuum Form Fitted #Uph-03 \$105.00
- 7 Daralex (contact surface only) #Uph-04 \$45.00
- 7 Rubatex (contact surface only) #Uph-05 \$45.00
- 7 Neoprene (contact surface only) #Uph-06 \$150.00

Other (special): **Note:** _____

8 **Embroidery** #Uph-15 \$73.00
adds 2-3 days to lead time

Script Text Block Text

Text _____

Thread Color _____

Step 7 Trunk Support Options (Sold as Pairs)

9 "Slim-Fit" Laterals (E0956)

- Zero inch offset brackets 6" long #3018-01XX-2 \$196.00
- Zero inch offset brackets 5" long #3018-02XX-2 \$196.00
- One inch offset brackets 6" long #3025-01XX-2 \$196.00
- One inch offset brackets 5" long #3025-02XX-2 \$196.00
- Two inch offset brackets 6" long #3017-02XX-2 \$196.00
- Two inch offset brackets 5" long #3017-01XX-2 \$196.00

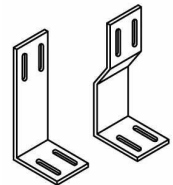

9 Lift & Swing-away Laterals (E0956/E1028)

- Lift & swing-away laterals #3030-02XX-2 \$607.00
flush mount and one inch offset brackets included

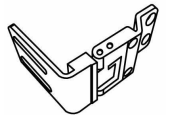

9 Quick Release/Adjustable Laterals (E0956/E1028)

- Zero inch offset quick release laterals #3040-02XX-2 \$607.00
- One inch offset quick release laterals #3041-02XX-2 \$607.00

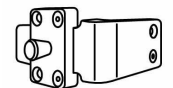

(XX = Must choose lateral base type and pad style/size) See next page

Accu-Fit Seating™

Back Options Sheet

Step 7

Trunk Support Options-Continued

9 Base Type / Pad Style / Size (Add pad part # to trunk support part #)

- Wood Oval** padded laterals 5x7 (Large) #32
- Wood Oval** padded laterals 4x6 (Medium) #31
- Wood Oval** padded laterals 3x5 (Small) #30
- ABS Flat** padded laterals 5x7 (Large) #12
- ABS Flat** padded laterals 4x6 (Medium) #11
- ABS Flat** padded laterals 3x5 (Small) #10
- ABS Curved** padded laterals 5x7 (Large) #22
- ABS Curved** padded laterals 4x6 (Medium) #21
- ABS Curved** padded laterals 3x5 (Small) #20

Included in hardware bracket pricing

- Custom Sized** lateral pads #0199 \$34.00
specify below
- 1/2" neoprene foam / dartex fabric side** (standard)
- 1/2" neoprene foam / reversed dartex fabric side** (no charge)
- Special foam or upholstery #0099** \$30.00

Custom lateral notes/drawing:

Step 8

Chest Harnesses & Options

Chest Harness Strap Risers/guides (K0108)

- 1" Webbing Strap risers #11041-01** \$46.00
- 2" Webbing Strap risers #11041-02** \$46.00

Butterfly Style (E0960)

- (X-Small) Butterfly style Hyper Cel® #11043-10 \$116.00
- (Small) Butterfly style Hyper Cel® #11043-11 \$116.00
- (Medium) Butterfly style Hyper Cel® #11043-12 \$116.00
- (Large) Butterfly style Hyper Cel® #11043-13 \$116.00
- (Small) Butterfly style (Vinyl) #11043-31 \$134.00
- (Medium) Butterfly style (Vinyl) #11043-32 \$134.00
- (Large) Butterfly style (Vinyl) #11043-33 \$134.00

- X-Small (A-11") (B-2") (C-5.5")
- Small (A-11.5") (B-2.25") (C-6")
- Medium (A-13.5") (B-4.5") (C-6.25")
- Large (A-14.5") (B-4.5") (C-7.75")

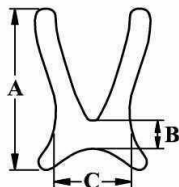

Standard-Fit Style (E0960)

- (X-Small) Standard-Fit Hyper Cel® #11041-10 \$116.00
- (Small) Standard-Fit Hyper Cel® #11041-11 \$116.00
- (Medium) Standard-Fit Hyper Cel® #11041-12 \$116.00
- (Large) Standard-Fit Hyper Cel® #11041-13 \$116.00
- (Small) Standard-Fit (Vinyl) #11041-31 \$134.00
- (Medium) Standard-Fit (Vinyl) #11041-32 \$134.00
- (Large) Standard-Fit (Vinyl) #11041-33 \$134.00

- X-Small (A-14") (B-4") (C-4")
- Small (A-17") (B-5") (C-5")
- Medium (A-20") (B-6") (C-6")
- Large (A-22") (B-7") (C-7")

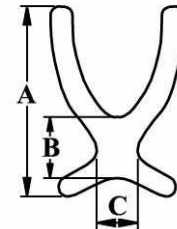

Zippered Standard-Fit Style (E0960)

- (X-Small) Standard-Fit (Rubatex) #11041-20 \$125.00
- (Small) Standard-Fit (Rubatex) #11041-21 \$125.00
- (Medium) Standard-Fit (Rubatex) #11041-22 \$125.00
- (Large) Standard-Fit (Rubatex) #11041-23 \$125.00

- X-Small (A-14") (B-4") (C-4")
- Small (A-17") (B-5") (C-5")
- Medium (A-20") (B-6") (C-6")
- Large (A-22") (B-7") (C-7")

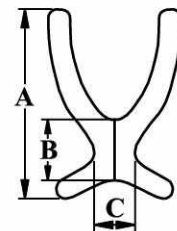

Slim-Fit Style (E0960)

- (X-Small) Slim-Fit Hyper Cel® #11042-10 \$116.00
- (Small) Slim-Fit Hyper Cel® #11042-11 \$116.00
- (Medium) Slim-Fit Hyper Cel® #11042-12 \$116.00
- (Large) Slim-Fit Hyper Cel® #11042-13 \$116.00

- X-Small (A-14") (B-4") (C-4")
- Small (A-17") (B-5") (C-5")
- Medium (A-20") (B-6") (C-6")
- Large (A-22") (B-7") (C-7")

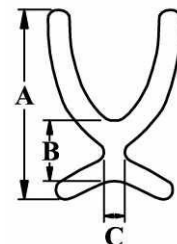

Step 9

Headrest Options

T-Nut Location (Headrest)

- Universal T-Nut Pattern for Headrests** (standard)
- Omit T-Nuts for Headrest
- Special T-Nut Pattern (specify) #13010-ST** \$12.00

Continued on next page

Accu-Fit Seating™

Back Options Sheet

Step 9

Headrest Options- Continued

Molded and Comfort Max Headrest Styles



Small Pad



Head-Neck Pad

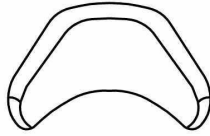

Large Pad



Contoured Pad



(Offset) Multi-Axis Headrests / Removable (E0955/E1028)

- Offset Multi-Axis Headrest **Comfort Max** Small Pad (reversed dartex) **#4008-39** \$350.00
- Offset Multi-Axis Headrest **Comfort Max** Small Pad (std dartex) **#4008-40** \$350.00
- Offset Multi-Axis Headrest **Comfort Max** Large Pad (reversed dartex) **#4008-41** \$350.00
- Offset Multi-Axis Headrest **Comfort Max** Large Pad (std dartex) **#4008-42** \$350.00
- Offset Multi-Axis Headrest / Small Pad **#4008-10** \$332.00
- Offset Multi-Axis Headrest / Large Pad **#4008-11** \$332.00
- Offset Multi-Axis Headrest / Head-neck Pad **#4008-12** \$332.00
- Offset Multi-Axis Headrest / Contoured Pad **#4008-13** \$332.00
- Offset Multi-Axis Headrest / without Pad **#4008-02** \$213.00

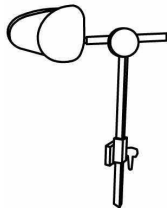

(Straight) Multi-Axis Headrest / Removable (E0955/E1028)

- Straight Multi-Axis Headrest **Comfort Max** Small Pad (reversed dartex) **#4009-39** \$350.00
- Straight Multi-Axis Headrest **Comfort Max** Small Pad (std dartex) **#4009-40** \$350.00
- Straight Multi-Axis Headrest **Comfort Max** Large Pad (reversed dartex) **#4009-41** \$350.00
- Straight Multi-Axis Headrest **Comfort Max** Large Pad (std dartex) **#4009-42** \$350.00
- Straight Multi-Axis Headrest / Small Pad **#4009-10** \$332.00
- Straight Multi-Axis Headrest / Large Pad **#4009-11** \$332.00
- Straight Multi-Axis Headrest / Head-neck Pad **#4009-12** \$332.00
- Straight Multi-Axis Headrest / Contoured Pad **#4009-13** \$332.00
- Straight Multi-Axis Headrest / without Pad **#4009-02** \$213.00

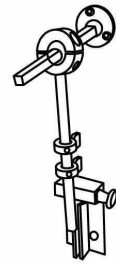

Flip-Down Headrest (E0955/E1028)

- Flip-Down Headrest **Comfort Max** Small Pad (reversed dartex) **#4006-39** \$475.00
- Flip-Down Headrest **Comfort Max** Small Pad (std dartex) **#4006-40** \$475.00
- Flip-Down Headrest **Comfort Max** Large Pad (reversed dartex) **#4006-41** \$475.00
- Flip-Down Headrest **Comfort Max** Large Pad (std dartex) **#4006-42** \$475.00
- Flip-Down Headrest / Small Pad **#4006-10** \$442.00
- Flip-Down Headrest / Large Pad **#4006-11** \$442.00
- Flip-Down Headrest / Head-neck Pad **#4006-12** \$442.00
- Flip-Down Headrest / Contoured Pad **#4006-13** \$442.00
- Flip-Down Headrest / without Pad **#4006-01** \$385.00

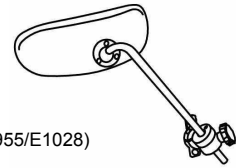

(Detachable) "Sway" Headrests (E0955/E1028)

extended reach!

- "Sway" Detachable with 2" Offset **Comfort Max** Small Pad (reversed dartex) **#4007-22-39** \$315.00
- "Sway" Detachable with 2" Offset **Comfort Max** Small Pad (std dartex) **#4007-22-40** \$315.00
- "Sway" Detachable with 2" Offset **Comfort Max** Large Pad (reversed dartex) **#4007-22-41** \$315.00
- "Sway" Detachable with 2" Offset **Comfort Max** Large Pad (std dartex) **#4007-22-42** \$315.00
- "Sway" Detachable with 2" Offset / Small Pad **#4007-22-10** \$301.00
- "Sway" Detachable with 2" Offset / Large Pad **#4007-22-11** \$301.00
- "Sway" Detachable with 4" Offset / Small Pad **#4007-44-10** \$301.00
- "Sway" Detachable with 4" Offset / Large Pad **#4007-44-11** \$301.00
- "Sway" Detachable with 4" Offset **Comfort Max** Small Pad (reversed dartex) **#4007-44-39** \$315.00
- "Sway" Detachable with 4" Offset **Comfort Max** Small Pad (std dartex) **#4007-44-40** \$315.00
- "Sway" Detachable with 4" Offset **Comfort Max** Large Pad (reversed dartex) **#4007-44-41** \$315.00
- "Sway" Detachable with 4" Offset **Comfort Max** Large Pad (std dartex) **#4007-44-42** \$315.00

(Fixed) "Sway" Headrests (E0955/E1028)

extended reach!

- "Sway" Fixed with 2" Offset / Small Pad **#4007-2-10** \$271.00
- "Sway" Fixed with 2" Offset / Large Pad **#4007-2-11** \$271.00
- "Sway" Fixed with 4" Offset / Small Pad **#4007-4-10** \$271.00
- "Sway" Fixed with 4" Offset / Large Pad **#4007-4-11** \$271.00

Footnotes:

- 1 Back starts as flat / planar back. Choose options / upgrades as needed.
- 2 Track mount hardware not available with Curved Back or Knob mount hardware.
- 3 (2) Knob mount brackets (top) and folding seat-to-back bracket(s) bottom, must specify seat-to-back bracket type.
- 4 Curved back upgrad is 3/8" thick ABS material. Maximum width available is 26".
- 5 1" Medium Polyurethane foam is standard and can be substituted as base-layer or mid-layer at no charge.
- 6 Gel-Inlay upgrade is located as top-layer unless noted otherwise.
- 7 Select material on contact surface of cushion only, standard Dartex on sides and bottom.
- 8 Embroidery is standard on front side of back cushion. Size of lettering will be determined by back size and amount of lettering.
- 9 Sold in pairs, must choose pad style / size with trunk support hardware.