

**Accu-Fit Back™
Order Form -MSRP
w/mounting hardware**

QUOTE ORDER PO# _____

Company Name: _____
 Contact Name: _____
 Phone #: _____
 Client Name: _____
 W/C Make: _____
 W/C Model: _____
 W/C (actual width) "Between the armrests" _____
 W/C Width: _____ Frame Color Name: _____

Back Height: _____
 Chest Width: _____
 Axilla Ht.: _____

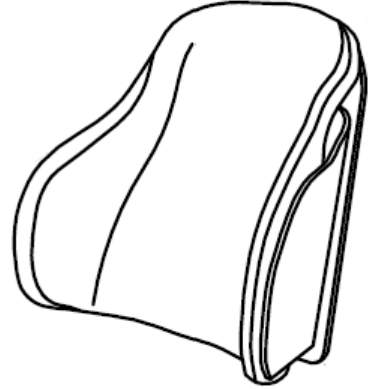

HCPC E2617

ACCU-FIT CONTOURED BACK.....#13009-02.....\$773.00
with Adjustable built-in lateral supports

NEW STANDARD FEATURES!
Includes: Embroidery and Accent Pin-Stripe!

Back-Mount Information

- Between The Rails**(Standard)
back width will be 3" narrower than chair width
 - Full Width (On top of the rails) *SEE NOTE PAGE 2
 - Oversized Back Upgrade..... #13010-05 \$114.00
actual back width 20-23" or >23" Height
 - Bariatric Oversized Back Upgrade..... #13010-06 \$201.00
actual back width 24-30"
-
- T-Nut for Attachment(no charge)
 - Track Mount Hardware**..... (Standard)
 - Omit T-Nuts (\$6.00)

Headrest Options

- T-Nut Location (Headrest)**
- Universal T-Nut Pattern for Headrests**..... (standard)
 - Omit T-Nuts for Headrest.....
 - Special T-Nut Pattern (specify) #13010-ST.....\$12.00

NEW! Secondary Lateral Bends.....(No Charge)
Increases lateral trunk support contact

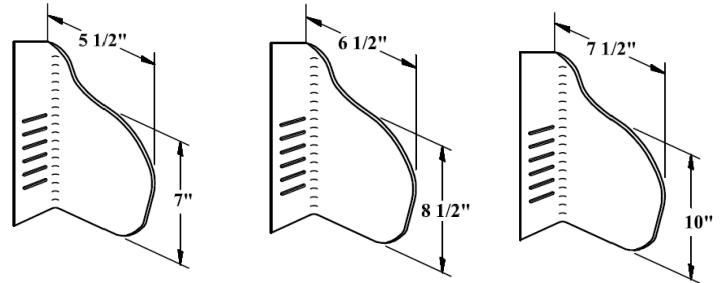

Note: overall back foam thickness will effect lateral support depth

- Small Laterals (No Charge) Medium Laterals (No Charge) Large Laterals (No Charge)
- Custom Size/Shape Laterals..... #13009-02X \$140.00

Custom Lateral Depth (A): _____

Custom Lateral Length (B): _____

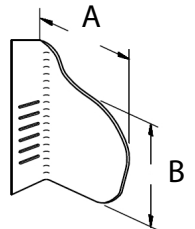

Foam In Place Kits

- Qty: _____ 1/2 unit size.....#13011-FIP.....\$154.00
 Medium Sunmate Soft Sunmate
- Qty: _____ 1-full unit size.....#13011-FIP2.....\$209.00
 Medium Sunmate Soft Sunmate

Office Use Only:

**Phone 800.676.5030
 Fax 330.545.6389
 www.icrehab.com**

Back Mounting Options

- Quick Clamp Hardware.....#1212.....(Standard)
Round back canes only

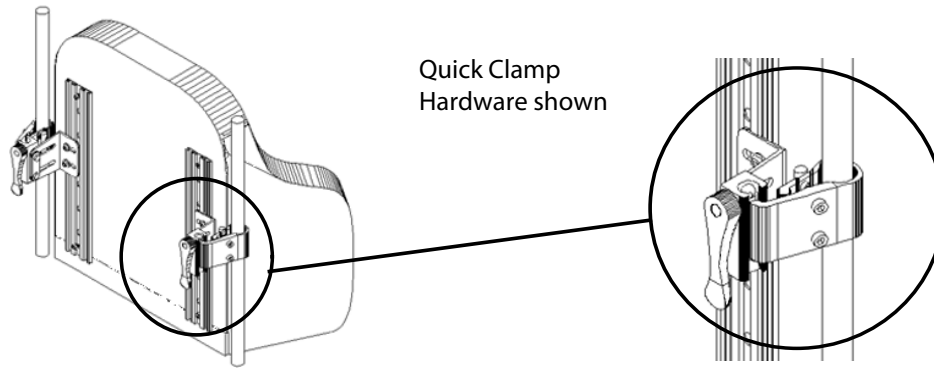

- NEW!** Universal Power Chair - UPC Back Mounting Plate Assembly.....#5-1496..... \$107.00
Directly mounts to power chair recline back interface plate. Height adjustable, lever-release detachable.

FITS: Permobil - All models except HD and standers.
Quantum - Q6/Q6000Z Series TB3 or TB2 (**see TB2 ordering note below) with power recline back.
Quickie - QM-7 Series with power recline back.
Quickie - Pulse with power recline back.

- Tilt Recline Hardware.....#1222.....(No Charge Option)
Recline Track Slide models only

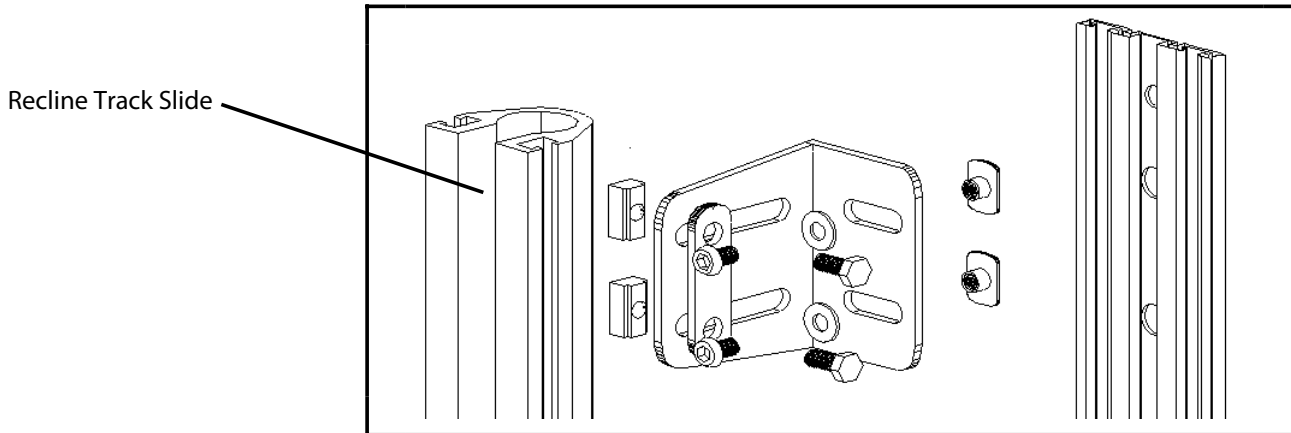

- J & L Hardware Mounting Kit #2300-99.....(No Charge Option)
select one "J" and one "L" length below

- | | | |
|--------------------------------------|--------------------------------------|--------------------------------------|
| <input type="checkbox"/> 2-Hole "J"s | <input type="checkbox"/> 1-Hole "L"s | <input type="checkbox"/> 5-Hole "L"s |
| <input type="checkbox"/> 4-Hole "J"s | <input type="checkbox"/> 2-Hole "L"s | <input type="checkbox"/> 7-Hole "L"s |
| <input type="checkbox"/> 7-Hole "J"s | <input type="checkbox"/> 3-Hole "L"s | <input type="checkbox"/> 9-Hole "L"s |
| <input type="checkbox"/> 9-Hole "J"s | | |

- Omit Mounting Hardware.....(\$35.00)
- Velcro Hook & Loop Attachment (back pan mount)#13009-PM.....(No Charge Option)
- Zero Inch Drop, U-Clamp Hardware Mounting Kit.....#2199-99.....(No Charge Option)
- One Inch Drop, U-Clamp Hardware Mounting Kit.....#2200-99.....(No Charge Option)
- Knob Release Kit (4-Point Mount)..... #13010-19..... \$430.00
- Knob Release Kit (2-Point Mount).....#13010-15..... \$159.00

includes seat-to-back bracket(s) Flush bracket 1" Offset 2" Offset 3" Offset
specify desired bracket style

*Full Width Backs come standard 1 inch less actual back width of wheelchair and include the secondary lateral bend of 90 degrees to properly fit into wheelchair frame.

**TB2 with True Comfort back and Cantilever armrests is not compatible with UPC Back Mount Plate Assembly.

Foam Options & Upgrades

(Base-Layer Foam)

Neoprene Foam

- 1/2" Neoprene Foam..... Standard

Poly Foams

- 1/2" Soft Polyurethane Foam..... #13030-05.....\$7.00
 1/2" Medium Polyurethane Foam..... #13030-07.....\$15.00
 1" Soft Polyurethane Foam..... #13030-06.....\$15.00
 1" Medium Polyurethane Foam..... #13030-08.....\$23.00

SunMate Brand Foam

- 1/2" Soft SunMate Foam..... #13030-13..... \$49.00
 1/2" Medium SunMate Foam..... #13030-15..... \$49.00
 1" Soft SunMate Foam..... #13030-14.....\$97.00
 1" Medium SunMate Foam..... #13030-16.....\$97.00

Visco Elastic

- 1/2" Super Soft Visco Elastic Foam#13030-09.....\$37.00
 1/2" Soft Visco Elastic Foam..... #13030-11.....\$37.00
 1" Super Soft Visco Elastic Foam.....#13030-10.....\$73.00
 1" Soft Visco Elastic Foam.....#13030-12.....\$73.00

(Mid-Layer Foam)

Poly Foams

- 1/4" Soft Polyurethane Foam..... #13040-01.....\$5.00
 1/2" Soft Polyurethane Foam..... #13040-02.....\$7.00
 1/2" Medium Polyurethane Foam #13040-04.....\$15.00
 1" Soft Polyurethane Foam..... #13040-03.....\$15.00
 1" Medium Polyurethane Foam..... #13040-05.....\$23.00

SunMate Brand Foam

- 1/2" Soft SunMate Foam..... #13040-11..... \$49.00
 1/2" Medium SunMate Foam..... #13040-13..... \$49.00
 1" Soft SunMate Foam..... #13040-12.....\$97.00
 1" Medium SunMate Foam..... #13040-14..... \$97.00

Visco Elastic

- 1/2" Super Soft Visco Elastic Foam.....#13040-06.....\$37.00
 1/2" Soft Visco Elastic Foam #13040-08.....\$37.00
 1" Super Soft Visco Elastic Foam #13040-07.....\$73.00
 1" Soft Visco Elastic Foam..... #13040-10.....\$73.00

Neoprene Foam

- 1/2" Neoprene Foam #13040-15.....\$27.00

(Top-Layer Foam)

Poly Foams

- 1/4" Soft Polyurethane Foam..... #13050-01..... \$5.00
 1/2" Soft Polyurethane Foam #13050-02..... \$7.00
 1/2" Medium Polyurethane Foam.....#13050-04.....\$15.00
 1" Soft Polyurethane Foam #13050-03..... \$15.00
 1" Medium Polyurethane Foam..... Standard

Neoprene Foam

- 1/2" Neoprene Foam..... #13050-14..... \$27.00

Polymer Gel

Overlay-full sheet

- 1/2" Poly-Gel (Cubed) #13050-16..... \$320.00
 1/2" Poly-Gel (Flat) #13050-15.....\$320.00
 1/2" Poly-Gel (Cubed) > 20" width or ht.....#13050-18.....\$402.00
 1/2" Poly-Gel (Flat) > 20" width or ht. #13050-17..... \$402.00

Inlay half-sheet

- 1/2" Poly-Gel Inlay (Cubed) #13050-20..... \$122.00
 Top Middle Bottom
 1/2" Poly-Gel Inlay (Flat)..... #13050-19.....\$122.00
 Top Middle Bottom

Visco Elastic

- 1/2" Super Soft Visco Elastic Foam..... #13050-06..... \$37.00
 1/2" Soft Visco Elastic Foam #13050-08..... \$37.00
 1" Super Soft Visco Elastic Foam..... #13050-07..... \$73.00
 1" Soft Visco Elastic Foam #13050-09..... \$73.00

SunMate Brand Foam

- 1/2" Soft SunMate Foam #13050-10..... \$49.00
 1/2" Medium SunMate Foam..... #13050-12..... \$49.00
 1" Soft SunMate Foam #13050-11..... \$97.00
 1" Medium SunMate Foam..... #13050-13..... \$97.00

NOTES:

Upholstery Options & Upgrades

To view upholstery Colors, please click link below

http://www.icrehab.com/files/Section%2012-Upholstery_Colors.pdf

Step- 1

Select **ONE** Fabric Style
For Contact Surface

<input type="checkbox"/> Dartex (fabric Side) Black-10
<input type="checkbox"/> Dartex Reversed (Smooth) Black-11
<input type="checkbox"/> Air-mesh Black-12
<input type="checkbox"/> Darlex Black-15
<input type="checkbox"/> Vinyl Black-17

Step- 2

Select **ONE** Fabric Style
For Non-Contact Surface

<input type="checkbox"/> Dartex (fabric Side) Black-10
<input type="checkbox"/> Dartex Reversed (Smooth) Black-11

NEW FEATURE!

Step- 3

Select **ONE** Fabric Style
For **ACCENT PIN-STRIFE!**

<input type="checkbox"/> Dartex (fabric Side) Black-10	<input type="checkbox"/> Dove Vinyl-40
<input type="checkbox"/> Dartex Reversed (Smooth) Black-11	<input type="checkbox"/> Graymist Vinyl-41
<input type="checkbox"/> Darlex Black-15	<input type="checkbox"/> Blue Vinyl-42
<input type="checkbox"/> Cordura Black-16	<input type="checkbox"/> Passion Purple Vinyl-43
<input type="checkbox"/> Vinyl Black-17	<input type="checkbox"/> Blueberry Vinyl-44
<input type="checkbox"/> Naugaform Black-18	<input type="checkbox"/> Butterscotch Vinyl-45
<input type="checkbox"/> Deep Violet Vinyl-20	<input type="checkbox"/> Red Swirl Vinyl-46
<input type="checkbox"/> Blue Sparkle Vinyl-21	<input type="checkbox"/> Space Blue Vinyl-47
<input type="checkbox"/> Gold Sparkle Vinyl-22	<input type="checkbox"/> Orange Vinyl-48
<input type="checkbox"/> Burgundy Sparkle Vinyl-23	<input type="checkbox"/> Hot Pink Vinyl-49
<input type="checkbox"/> Hot Pink Sparkle Vinyl-24	<input type="checkbox"/> Sun Yellow Vinyl-50
<input type="checkbox"/> Fuschia Sparkle Vinyl-25	<input type="checkbox"/> CrocusVinyl-51
<input type="checkbox"/> Silver Sparkle Vinyl-26	<input type="checkbox"/> Sky Blue Vinyl-52
<input type="checkbox"/> Charcoal Sparkle Vinyl-27	<input type="checkbox"/> Carbon Vinyl-53
<input type="checkbox"/> Green Sparkle Vinyl-28	<input type="checkbox"/> Greystone Vinyl-54
<input type="checkbox"/> Cascade Sparkle Vinyl-29	<input type="checkbox"/> Fern Vinyl-55
	<input type="checkbox"/> Crocus Vinyl-56

Slip Covers / Liner's

<input type="checkbox"/> Incontinent Inner-Liner Cover.....#13008-IC.....\$122.00								
<input type="checkbox"/> Removable / Stretchy Slip Cover.....#13011-NC.....\$150.00								
<input type="checkbox"/> Dual Slip covers.....#13011-NC2.....\$300.00								
<table style="width: 100%; border: none;"> <tr> <td style="text-align: center; width: 50%;"><u>Choose Contact Surface</u></td> <td style="text-align: center; width: 50%;"><u>Choose Non-Contact Surface</u></td> </tr> <tr> <td><input type="checkbox"/> Dartex (fabric Side) Black-10</td> <td><input type="checkbox"/> Dartex (fabric Side) Black-10</td> </tr> <tr> <td><input type="checkbox"/> Dartex Reversed (Smooth) Black-11</td> <td><input type="checkbox"/> Dartex Reversed (Smooth) Black-11</td> </tr> <tr> <td><input type="checkbox"/> Air-mesh Black-12</td> <td></td> </tr> </table>	<u>Choose Contact Surface</u>	<u>Choose Non-Contact Surface</u>	<input type="checkbox"/> Dartex (fabric Side) Black-10	<input type="checkbox"/> Dartex (fabric Side) Black-10	<input type="checkbox"/> Dartex Reversed (Smooth) Black-11	<input type="checkbox"/> Dartex Reversed (Smooth) Black-11	<input type="checkbox"/> Air-mesh Black-12	
<u>Choose Contact Surface</u>	<u>Choose Non-Contact Surface</u>							
<input type="checkbox"/> Dartex (fabric Side) Black-10	<input type="checkbox"/> Dartex (fabric Side) Black-10							
<input type="checkbox"/> Dartex Reversed (Smooth) Black-11	<input type="checkbox"/> Dartex Reversed (Smooth) Black-11							
<input type="checkbox"/> Air-mesh Black-12								

Embroidery.....#Uph-15..... Standard
 Script Lettering **Block Lettering**

TEXT: _____

Thread will be color matched to "Colored Fabric" if selected

THREAD COLOR: _____

Upholstery Notes:

Chest Harness Options

Standard-Fit Style (E0960)

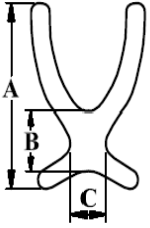

Slim-Fit Style (E0960)

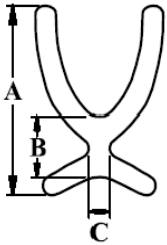

Butterfly Style (E0960)

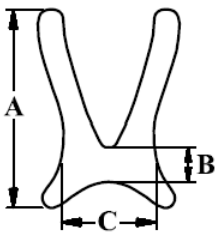

H-2 Style (E0960)

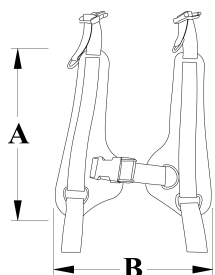

Choose Size

- X-Small Harness
X-Small (A-14") (B-4") (C-4")
- Small Harness
Small (A-17") (B-5") (C-5")
- Medium Harness
Medium (A-20") (B-6") (C-6")
- Large Harness
Large (A-22") (B-7") (C-7")

- X-Small Harness
X-Small (A-14") (B-4") (C-4")
- Small Harness
Small (A-17") (B-5") (C-5")
- Medium Harness
Medium (A-20") (B-6") (C-6")
- Large Harness
Large (A-22") (B-7") (C-7")

- X-Small Harness
X-Small (A-11") (B-2") (C-5.5")
- Small Harness
Small (A-11.5") (B-2.25") (C-6")
- Medium Harness
Medium (A-13.5") (B-4.5") (C-6.25")
- Large Harness
Large (A-14.5") (B-4.5") (C-7.75")

- X-Small Harness
X-Small (A-12") (B-7.5")
- Small Harness
Small (A-14") (B-8")
- Medium Harness
Medium (A-16.5") (B-8.5")
- Large Harness
Large (A-19") (B-9")

Choose Style

- Hyper-cel Style.....\$116.00
- Zippered Style.....\$125.00
- Vinyl Face Style.....\$134.00
- No-Stretch Style.....\$138.00

- Hyper-cel Style.....\$116.00
- Vinyl Face Style.....\$134.00

- Hyper-cel Styl.....\$116.00
- Vinyl Face Style.....\$134.00
- No-Stretch Style.....\$138.00

- Hyper-cel Style.....\$116.00
- Vinyl Face Style.....\$134.00
- No-Stretch Style.....\$138.00

Extras

Chest Harness Strap Risers/Guides (K0108) \$46.00

- 1" Webbing Strap Risers
#11041-01
- 2" Webbing Strap Risers
#11041-02

Headrest & Hardware Options

Choose Hardware (E1028).....



(Offset) Multi-Axis Headrests / Removable

Offset Multi-Axis Headrest
\$213.00

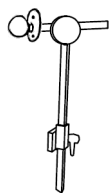

(Straight) Multi-Axis Headrest / Removable

Straight Multi-Axis Headrest
\$213.00

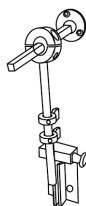

(Flip-Down) Headrest

Flip-Down Headrest
\$385.00

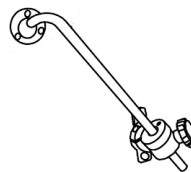

(Detachable) "Sway" Headrests

2" Offset / 1" Ball \$222.00
 4" Offset / 1" Ball \$222.00

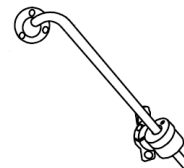

(Fixed) "Sway" Headrests

2" Offset / 1" Ball \$192.00
 4" Offset / 1" Ball \$192.00

Molded Headrest Pads (E0955).....

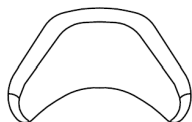

Large Molded 11"
\$119.00



Small Molded 9"
\$119.00



Molded Head/Neck
\$119.00



Molded Contoured
\$119.00

Premium Headrest Pads (E0955).....

Tri-Panel



Small Tri-panel (4Hx4L)
\$298.00



Large Tri-panel (5Hx5L)
\$298.00

- Air Mesh with STD Dartex on non-contact
- Air Mesh with Reversed Dartex on non-contact

Contact Surface

- STD Dartex
- Reversed Dartex

Non-Contact Surface

- STD Dartex
- Reversed Dartex
- Naugahyde
- Colored Naugayde (Same Color as Back)

Comfort Max

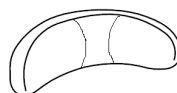

Small Comfort Max (9")
\$137.00

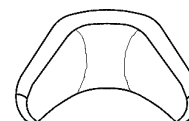

Large Comfort Max (11")
\$137.00

- STD Dartex
- Reversed Dartex
- Air Mesh with STD Dartex on non-contact
- Air Mesh with Reversed Dartex on non-contact